



MOTOROLA *transistorized voltmeter*

MODELS

S1051C
S1053C



MOTOROLA

TRANSISTORIZED AC VOLTMETER

MODELS S1051C AND S1053C

AE PD-9830-O (CE2286-V21)

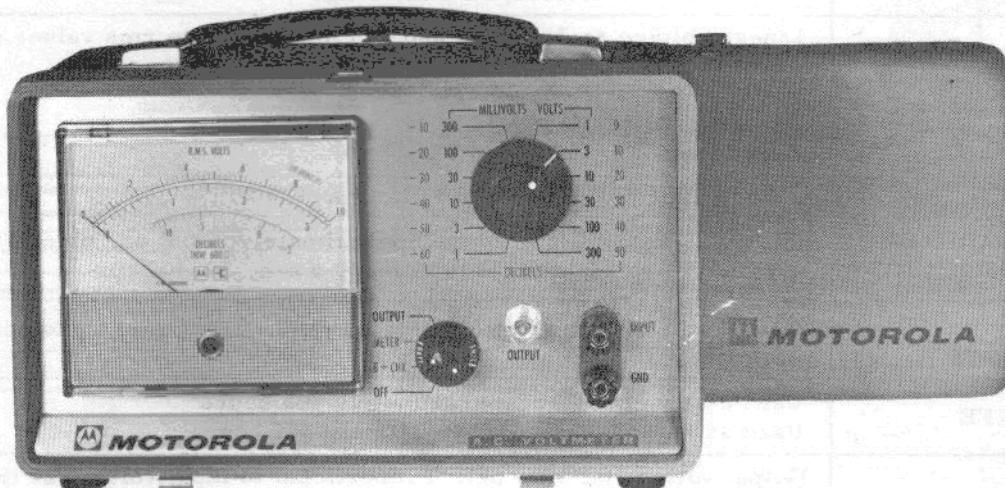

MODEL S1053C
TRANSISTORIZED AC VOLTMETER



MOTOROLA INC.

COMMUNICATIONS DIVISION

ENGINEERING PUBLICATIONS

1301 E. ALGONQUIN ROAD

SCHAUMBURG, ILLINOIS 60172

Copyright 1973 by Motorola, Inc.
Printed in U.S.A.
2/27/73-UP

68P81021A05
Issue - C

GUARANTEED PERFORMANCE SPECIFICATIONS

MODELS	S1051C (battery operated)	S1053C (a-c/battery operated)
MEASUREMENTS	1 millivolt to 300 volts full scale on 12 ranges. -72 db to +52 db on 12 ranges.	
ACCURACY	±2% of full scale from 50 cps to 300 kc and ±3% of full scale from 20 cps to 50 cps, 300 kc to 1 mc; except ±3% of full scale from 20 cps to 100 kc and ±5% of full scale from 100 kc to 1 mc on the 300 volt range (at 25°C (77°F)).	
INPUT IMPEDANCE	1 to 300 mv range; greater than 1 megohm shunted by 30 uuf. 1 to 300 volt range; greater than 10 megohms shunted by 15 uuf	
OVERLOAD PROTECTION	VOLT range: Maximum of 550 volts (sum of d-c and a-c peak voltages) MILLIVOLT range: Maximum of 110 volts rms continuous; 220 volts rms for 10 seconds or less; 600 v d-c	
NOISE	Less than 0.1 mv meter deflection with input terminated with 100K ohm resistor (shielded) on 1 mv range	
METER CALIBRATION	Linear voltage scales: 0-1 and 0-3 (calibrated to rms values of a sine wave) Voltage ranges: 1, 3, 10, etc. steps DB scale calibration: -12 to +2 Zero level: 1 milliwatt in 600 ohms	
METER	0-50 microampere taut-band movement	
AC INPUT REQUIREMENTS (S1053C ONLY)	105-130 v a-c, 50-400 cps at approximately 5 ma; or, using SKN6009A 230/117 v a-c adapter cable kit; 230 v a-c, 50-400 cps	
DC INPUT REQUIREMENTS	An 8.4 volt mercury battery (Mallory No. TR-136 or equivalent)	
BATTERY LIFE	Used as a voltmeter: approximately 400 hours Used as an amplifier: approximately 300 hours	
AMPLIFIER CHARACTERISTICS	Output voltage (at 400 cps): Proportional to input voltage as indicated by meter deflection (meter and amplifier are separate functions and cannot be used simultaneously), 1.4 volts (peak to peak) or 0.5 volt (rms) into 600 ohm (or more) resistive load corresponding to full scale meter reading. Frequency response: ±0.5 db from 20 cps to 100 kc, approx. 3 db down at 1 mc into 600 ohm or more (resistive load) and shunt capacity not more than 200 uuf. Distortion (20-30°C): Less than 1% with 1K ohm (or more) resistive load shunted by not more than 200 uuf from 20 cps to 20 kc. Maximum voltage gain (400 cps): 500 (54 db) on 1 mv range	
WEIGHT	6 lb. 7 oz.	
DIMENSIONS	10-1/4" x 6-1/2" x 5-3/4" (approx.)	

SPECIFICATIONS SUBJECT TO CHANGE WITHOUT NOTICE

FOREWORD

CLAIM FOR DAMAGE IN SHIPMENT

If any damage to the shipping container is apparent upon receipt, the delivering driver should be requested to note such damage on all copies of the freight bill. This is for your protection should the material have received damage.

The equipment should be unpacked immediately, examined for damage and tested. If it fails to operate properly, or is damaged in any way, a claim should be filed with the carrier. The claim should be filed within 48 hours after receipt, if possible, or during a period not to exceed 15 days.

A full report of such damage should be obtained from the claim investigator, who will call upon you. For the purpose of this report, the shipping container and all packing materials should be retained for the investigator to examine.

The investigator's report should then be forwarded to:

Motorola Communications & Electronics, Inc.
Parts and Service Department
1301 E. Algonquin Road
Schaumburg, Illinois 60172

Include model number and serial number when referring to the instrument for any reason.

Arrangements for repair or replacement will be made and you will be advised of the disposition of the instrument.

REPAIR AND/OR RECALIBRATION

Because of its complexity it is recommended that the instrument be returned to the factory for repair and/or calibration. Return to:

Motorola Communications & Electronics, Inc.
Parts and Service Department
1301 E. Algonquin Road
Schaumburg, Illinois 60172

Before shipping the instrument notify the Department at the above address of the service required. Refer to the instrument by model number and serial number. On receipt of the information, you will be informed of shipping instructions. If requested, an estimate of the charges will be made before work begins, provided the instrument is not covered by the warranty.

SHIPPING

The unit employs a meter movement which, though electrically rugged, should be protected from mechanical shock. Therefore, the instrument should be surrounded by three inches of excelsior or similar absorbing material and then packed in a strong exterior container. It should be shipped via truck, railway express, airfreight, or air express. The instrument should not be handled roughly during packing.

WARRANTY

This Motorola instrument is guaranteed by Motorola for a period of one year after delivery to the original purchaser against defects in design, material, and workmanship. Our liability under this warranty is limited to servicing or adjusting any instrument returned to the factory Service Department for that purpose and to replace any defective parts thereof.

This warranty is effective for one year after delivery to the original purchaser when the instrument is returned, transportation charges prepaid by the original purchaser, and when upon our examination it is disclosed to our satisfaction to be defective. If the fault has been caused by misuse or abnormal conditions of operation, repairs will be billed at the net price of necessary parts and a service charge at Motorola's then prevailing labor rate. In this case, an estimate will be submitted before the work is started.

This warranty is in lieu of all other warranties, expressed or implied and all other obligations or liabilities on Motorola part.

If any fault develops, the following steps should be taken:

1. Notify us at the following address:

Motorola Communications & Electronics, Inc.
Parts and Service Department
1301 E. Algonquin Road
Schaumburg, Illinois 60172

Give full details of the difficulty, and include model number and serial number. Upon receipt of this information, we will give you service data or shipping instructions.

2. Upon receipt of shipping instructions, forward the instrument prepaid to the above address, or to the authorized repair station indicated on the instructions. If requested, an estimate of the charges will be made before the work begins, if the instrument is not covered by the warranty.

CONTENTS

<u>SECTION</u>	<u>PAGE</u>
Guaranteed Performance Specifications	ii
Model Chart	EPD-9829-O
INTRODUCTION	1
DESCRIPTION	1
a. Functions	1
b. Instrument Characteristics	1
c. Construction	1
d. AC Power Supply	1
METER SCALES	1
a. AC Voltage Scales	1
b. Decibel Scale	1
c. Battery Condition Scale	2
CONTROLS AND INPUT TERMINATIONS	2
a. Range Selector Switch	2
b. OFF-B+ CHK. -METER-OUTPUT Functions Switch (Model S1051C)	2
c. OFF-B+ CHK. -METER-OUTPUT Functions Switch (Model S1053C)	2
d. Input Terminations	2
e. Output Termination	2
f. Test Lead Accessory	2
g. 230/117 Volt Adapter Cable	3
CIRCUIT DESCRIPTION	3
a. Input attenuation	3
b. Pre-Amplifier	3
c. Amplifier	3
d. Output Stage	3
e. Meter Circuit	3
f. Power Supply (S1053C Only)	4
OPERATION	4
a. Mechanical Meter Zero	4
b. Operation from an AC Source	4
c. Operation from Internal Battery	4
d. AC Voltage Measurement	4
e. Power Measurements	5
f. Examples of AC Voltage and Power Measurements	5
g. Amplifier Operation	5
h. Battery Conservation	6
TEMPERATURE EFFECTS	6
APPLICATIONS	6
a. General	6
b. Voltmeter	6
c. Amplifier	8
CALIBRATION AND MAINTENANCE	8
a. General	8
b. Calibration	8
c. Troubleshooting	13
SCHEMATIC DIAGRAMS AND PARTS LIST	
a. Model S1051C	15
b. Model S1053C	16

1. INTRODUCTION

The Motorola Transistorized AC Voltmeters offer many advantages not found in a-c vacuum tube voltmeters. Small physical size, light weight and full transistorization permit complete portability for field use. The absence of heat producing elements, such as tubes and transformers, lessens the need for frequent recalibration and increases component life. The Model S1051C is battery operated. The Model S1053C, in addition to being battery operated, contains an a-c power supply which operates from a 117 v a-c, 50-400 cps source. A detachable power cord is supplied with the Model S1053C. The SKN6009A 230/117 Volt Adapter Cable Kit (an optional item not furnished with the standard Model S1053C) permits operation from a 230 volt, 50-400 cps power source.

2. DESCRIPTION

a. Functions

These transistorized a-c voltmeters are capable of accurately performing the following functions:

(1) AC voltage measurement from 0.1 millivolt to 300 volts in a frequency range of 20 cycles per second to 1 megacycle.

(2) Power measurements from -72 to +52 dbm when measured across 600 ohm impedance (0 dbm = 1 milliwatt into 600 ohms).

(3) Comparative power measurements from -72 to +52 db (when measured at the same impedance level).

(4) High gain isolation amplifier with high input resistance and low impedance output for amplification of low level audio or r-f signals.

b. Instrument Characteristics

This instrument is similar to many other a-c voltmeters in that the meter movement responds to average values of applied voltages. The meter scale is calibrated to read the rms value of a sinusoidal waveform. When the input waveform departs from a pure sine wave, the meter indication will be in error by the ratio of the average value to the rms value of the incoming waveform. (See figures 1 and 2 in paragraph 8.)

c. Construction

Although primarily designed for laboratory use, these instruments, being self-powered, are quite suitable for portable use without sacrificing the accuracy or versatility of a laboratory instrument. A detachable metal cover protects the front panel from damage that might occur in portable use. Clips for storing the meter cable or other accessories are mounted on the inside of the cover.

d. AC Power Supply

The power supply of the Model S1053C contains a conventional half-wave diode rectifier circuit with a capacitor input filter connected to the output. A Zener diode is connected across the output for voltage regulation. The input step-down transformer is installed in the line cord circuit and isolates the instrument case from the a-c source. The ground pin of the line cord is not connected to the instrument case. The line cord is detachable when portable operation with an internal battery is desired.

3. METER SCALES

The meter is calibrated in two linear a-c voltage scales, a decibel scale and a battery condition scale. It uses a 0-50 microampere taut-band movement with non-linearity less than 1% of full-scale deflection. Damping is adjusted to eliminate "overshoot" for convenience in reading the pointer indication. The meter scales and their applications are as follows:

a. AC Voltage Scales

The two linear scales (black) are used to measure rms values of a-c voltages. The upper scale is graduated to a full-scale value of 1.0 and the lower scale is graduated to a full-scale reading of 3.2. All a-c voltages from 0.1 millivolt to 300 volts rms are read directly from these scales using the full scale factors appearing on the range selector switch positions.

b. Decibel Scale

The DECIBEL scale (red) is used for dbm measurement when measuring power level into a 600 ohm impedance or comparative db levels when measured at the same impedance level. The scale

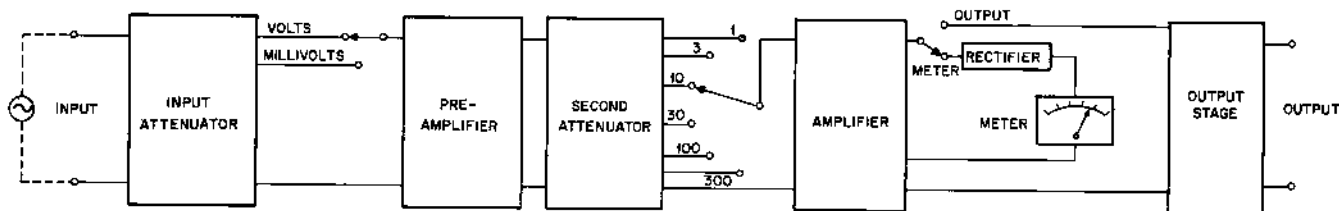

BLOCK DIAGRAM

BEFD-9635-C

is calibrated from -12 to +2 and readings are obtained by using the algebraic sum of the range selector switch position and the meter pointer indication.

c. Battery Condition Scale

The LINE OR BATTERY O. K. scale (red) is the small scale above and to the right of the upper a-c voltage scale. The meter pointer indication within the scale limits is a relative indication of battery condition (under load) or of the a-c power supply output.

4. **CONTROLS AND INPUT TERMINATIONS**

All controls and input terminations used for measurement are located on the front panel of the instrument.

a. Range Selector Switch

This is a 12-position switch used to select the proper voltage or decibel range. The correct switch position is determined by the level applied to the input.

b. OFF-B+ CHK. -METER-OUTPUT
Function Switch (Model S1051C)

This switch permits a check of the internal battery condition under load in addition to turning the instrument on or off. The meter is connected to the battery under a simulated load when the switch is placed in the B+ CHK. position. Voltage measurements may be made in the METER position. Amplifier output is connected to the front panel BNC connector in the OUTPUT position.

c. OFF-B+CHK. -METER-OUTPUT
Function Switch (Model S1053C)

This is an 8-position (continuous rotation) switch which performs four functions: OFF, B+ CHK., METER and OUTPUT (see photograph on

frontispiece of this manual). The markings on the knob (pointer marks labeled LINE and BATT) automatically indicate whether the internal battery or the a-c line is in use as a power source. METER and OUTPUT functions are the same as those described in the preceding paragraph.

d. Input Terminations

The units are equipped with two binding posts that are mounted on a molded polystyrene base selected for its low loss characteristics at high frequencies. These "six-way" binding posts are used to make electrical connections with single and double pin banana type plugs, tipped plugs, spade lugs, alligator clips and bare wire.

e. Output Termination

The units are equipped with a BNC coaxial receptacle which is mounted on the front panel. This receptacle furnishes amplifier output for external applications when the function selector switch is in the OUTPUT position.

WARNING

The voltmeters have the GND terminal connected to the instrument case. Extreme caution should be exercised when connecting this terminal to off ground potentials (referenced to ground of the circuit being measured) to minimize shock hazard to operating personnel. When high d-c potentials are present, connect a large coupling capacitor in series with this terminal and a 1-megohm resistor between this terminal and referenced ground of the circuit being measured.

f. Test Lead Accessory (Optional Accessory)

The SKN6001A Meter Cable Kit is available as an optional test lead accessory. It is a 30" shielded cable terminated at one end in a standard two-pin banana plug. The probe end of the cable is terminated in two insulated alligator clips.

g. 230/117 Volt Adapter Cable (Optional Accessory)

The Model SKN6009A 230/117 Volt Adapter Cable is an optional accessory, and will provide a 117 v a-c source for the S1053C Transistorized AC Voltmeter when it (the adapter) is plugged into a 230 v a-c line. The adapter cable consists of approximately six feet of 3-conductor cable, a small cylindrical housing containing a potted step-down transformer and a 3-pin connector which mates with the plug on the a-c voltmeter power cable. An a-c line plug is not supplied with the cable due to the lack of standardization of the types used. When connecting an a-c line plug, connect the BLK and WHT leads to the 230 volt line and connect the GRN lead to ground.

h. Battery Installation and Aging

The battery (60B82292H01 or Mallory TR136) must be installed with the positive end (+) first as indicated on the battery plug button.

Upon installing a new battery there is approximately a 5 hour period for the battery to age to its long term voltage value. During this period of time the voltmeter error may be increased by approximately $\pm 1/2\%$ of full scale. If this error is not tolerable it is suggested that the battery be pre-aged. This can be accomplished after installation of a new battery by placing the voltmeter function switch in the B+ check position for 5 hours.

i. Needle Kick

Kicking of the needle immediately after the instrument is turned on is due to charging and/or discharging of the electrolytic capacitors. The needle kick can also be noticed especially when changing the range switch between 300 MV and 1 V ranges, and 1 V and 3 V ranges.

It is suggested that the instrument be turned on for at least two minutes before using to reform the charge on the electrodes of the electrolytic capacitors.

5. CIRCUIT DESCRIPTION

Refer to the block diagram for general information and to the schematic diagram for detailed wiring information.

a. Input Attenuation

Two precision resistor attenuators are used to reduce the input level. The input attenuator

(used only on ranges above 1 volt) reduces the input level by 60 db. A second attenuator at the output of the pre-amplifier is used to accomplish additional attenuation in 10 db steps. A three section potentiometer permits adjustment for minor loading variations or resistance changes of the second attenuator.

b. Pre-amplifier

The pre-amplifier presents a high input impedance necessary to prevent circuit loading and resultant erroneous readings in many applications. Transistor Q1 is connected in a "bootstrap" configuration. The normally low input impedance of transistor amplifiers is increased through the use of feedback to the high level required for accurate measurement. Two protection diodes (CR1 and CR2) are connected in the base circuit of the input transistor (Q1) to protect the instrument from excessive input voltages. A maximum of 550 volts peak (sum of the a-c and d-c voltages) may be applied on any VOLT range without damage to the instrument. A maximum of 110 volts rms continuous or 220 volts rms for 10 seconds or less can be applied on any MILLIVOLT range without damage.

c. Amplifier

The main amplifier consists of 3 pairs of direct-coupled common emitter stages followed by an emitter follower output stage. The negative voltage is fed back from the collector of the second stage to the emitter of the first stage in each direct coupled pair.

The input impedance of the first pair (Q3 and Q4) presents a fixed load for the second attenuator. The input impedance is essentially the parallel combination of R22 and R23 because the input impedance of Q3 is raised to a very high value by the use of negative feedback.

A variable gain control (R36) in the emitter circuit of Q5 controls the net gain of Q5 and Q6 for calibration purposes. C28 and R48 are used for high frequency compensation.

In the METER position of the function selector switch, the meter and the rectifier circuit are connected in the negative feedback loop (from the collector of Q8 to the emitter of Q7). Also (with the switch in the METER position), the rear section of switch S2B disconnects d-c bias from the base of Q9 and the collector of Q8. When the function selector switch is in the OUTPUT position, R51 and C29 are substituted for the meter

rectifier circuit in the collector circuit of Q8, and switch S2B applies bias to the base of Q9 by connecting it to the collector of Q8.

Since the function selector switch in the OUTPUT position disconnects the rectifier meter circuit, distortion due to the rectifier diodes is eliminated. Thus, the amplifier output contains little distortion.

d. Output Stage

When the collector of Q8 is connected to the base of Q9 through section S2B of the function selector switch, an output signal appears at the emitter of the N-P-N transistor Q9. This signal is coupled to the output connector on the front panel through C31, a 100 uuf capacitor and a shielded cable. The output impedance of the amplifier is approximately 50 ohms.

e. Meter Circuit

The output of Q8 is applied to a full wave bridge rectifier consisting of two high frequency diodes (CR3 and CR4). A 0-50 microampere taut-band meter movement (M1) is connected across the output of the rectifier to measure the resultant d-c current. Signal current from the meter circuit is fed back to the amplifier to obtain gain stability and meter linearity over the entire bandwidth.

f. Power Supply (S1053C Only)

The Model S1053C AC Voltmeter may be powered from either an internal battery or from the rectifier circuit which operates from the a-c line. The rectifier power supply consists of transformer T1 and diode rectifier CR5. Filtering is accomplished by means of the filter network circuit C32, C33 and R55. Zener diode CR6 provides voltage regulation. Transformer T1 is built into the large cylindrical plug P1 which is plugged into the a-c line; a cable from P1 carries low voltage secondary current and is terminated at the other end by P2 which plugs into J1 on the case of the instrument.

6. OPERATION

a. Mechanical Meter Zero

A screwdriver adjustment is used to mechanically zero the meter. It is located on the meter cover. If the meter pointer does not rest directly in line with the 0 line of the voltage scales when the power switch is in the OFF position

(instrument upright on feet), turn this adjustment left or right until the pointer is directly in line with the 0 line.

b. Operation from an AC Source (Model S1053C)

(1) Connect the female plug end of the power cable to the receptacle at the rear of the instrument case.

(2) Connect the male plug end of the power cable to a 117 v a-c (50-400 cps) receptacle. A 230 v a-c power source may be reduced to the required 117 v a-c with the Model SKN6009A 230/117 VAC Adapter Cable Kit.

(3) Place the LINE side of the function switch in the B+ CHK. position and check the power supply output by observing the reading on the LINE OR BATTERY O. K. scale.

(4) Rotate the LINE side of the function switch to the METER position for voltage measurements or to the OUTPUT position for amplifier applications.

NOTE

Should sensitive measurements require complete isolation from r-f energy which may be present on the a-c line, switch the Model S1053C to battery operation and remove the power cable from the instrument housing.

c. Operation From Internal Battery

Place the function switch in the B+ CHK. position. A new battery will give a meter indication near the upper limits of the LINE OR BATTERY O. K. scale. After a few hours of operation, the meter indication will be approximately mid-scale. If the meter indication just reaches or falls below the lower limits of the scale, the accuracy of the instrument will be affected and the battery must be replaced. Refer to the MAINTENANCE paragraph of this manual for detailed replacement information.

d. AC Voltage Measurement

(1) Place the function switch in the ON position.

(2) A rapid check of the condition of the instrument may be performed by placing the range selector switch in the 1 MILLIVOLT position. The meter indication should be anywhere from 0.1 to full or off-scale deflection depending on the proximity of stray electric fields from a-c power lines.

(3) Place the range selector switch in a VOLTS or MILLIVOLTS position corresponding to an expected meter indication in the upper 2/3 of the meter scale. Readings in this portion of the scale are most nearly accurate and ranges should be selected to accomplish this whenever possible.

NOTE

When in doubt as to expected voltage levels, good practice is to place the range selector switch in the least sensitive (highest voltage) range and progressively increase the sensitivity (switch to lower voltage ranges) until a reading in the upper 2/3 of the scale is obtained. Note also that in the METER position, the amplifier output is disabled.

(4) Connect the input terminals across the voltage source to be measured.

WARNING

These voltmeters have the GND terminal connected to the instrument case. Extreme caution should be exercised when connecting this terminal to off ground potentials (referenced to ground of the circuit being measured) to minimize shock hazard to operating personnel. When high d-c potentials are present, connect a 1 megohm resistor between this terminal and referenced ground to the circuit being measured, and bypass this resistor with a high voltage capacitor of a value of .22 ufd or larger.

e. Power Measurements

Power measurements in terms of db or dbm are made in the same manner as a-c voltage mea-

TABLE 1

Range Selector Switch Position	Scale	Meter Indication	Level
300 VOLTS	0-3.2	2.1	210 volts a-c rms
10 VOLTS	0-1.0	.64	6.4 volts a-c rms
3 MILLIVOLTS	0-3.2	2.6	0.0026 volts a-c rms
1 MILLIVOLTS	0-1.0	.72	0.00072 volts a-c rms
+50 DECIBELS	DECIBEL	+1	+51 decibels
+20 DECIBELS	DECIBEL	-5	+15 decibels
-60 DECIBELS	DECIBEL	-8	-68 decibels
-40 DECIBELS	DECIBEL	+2	-38 decibels

surements except that the meter indication is read from the DECIBEL scale. When making measurements in terms of dbm, the measurements must be made across a 600 ohm impedance (0 dbm = 1 milliwatt into 600 ohms). Comparative power level measurements in terms of db may be made by noting the difference in db readings obtained when each measurement is made across the same value of impedance. The correct level in db or dbm is the algebraic sum of the meter indication on the DECIBEL scale and the range selector switch DECIBEL position.

f. Examples of AC Voltage and Power Measurements

The following table lists a number of meter indications and their respective voltage and power levels.

g. Amplifier Operation

(1) Place the function switch in the METER position. (In the Model S1053C voltmeter, there are two markings--LINE and BATT--one of which should be turned to the METER position, depending upon whether the meter is powered from the a-c line or from the internal battery.)

(2) Place the range selector switch in a VOLTS or MILLIVOLTS position such that the expected meter indication will register in the upper 2/3 of the meter scale. The output voltage of the amplifier will depend on this setting, and will be approximately 0.5 volt (rms) for a full scale meter reading and 0.25 volt (rms) at half scale deflection. Be sure to make this voltage measurement if the input voltage is not known. An excessive overload input signal can damage the instrument. See the overload protection limits in Table of Guaranteed Performance Specifications.

(3) Place the function switch in the OUTPUT position; this will disconnect the meter circuitry and provide an amplified output signal. When the function switch is in the OUTPUT position, battery drain is increased by approximately 40% (or 1.2 ma). (Although the OUTPUT position of the function switch disconnects the rectifier circuit to eliminate distortion which would be caused by the rectifier diodes, the meter may show some deflection at higher frequencies due to capacitive coupling of the switches. The meter may deflect either above or below zero if the amplifier is connected to a noisy source or is overdriven.)

NOTE

Minimum loading to be used with the amplifier must be not less than 600 ohms resistive and/or not more than 200 uuf capacitive load. The output cable may be RG-58A/U, RG-59/U, or other r-f cable fitted with a female RG-59/U cable have a capacity of approximately 24 uuf per foot; avoid using long cable at the output.

(4) Output voltage can be attenuated in 10 db steps by turning the range selector switch to the next higher range. Example: If the input is 1 mv and the range selector switch is in the 1 MILLIVOLT position, output will be .5 volts rms, an approximate voltage gain of 54 db. To attenuate the output 10 db, turn the range selector switch to the 3 MILLIVOLT setting; the output will then be 0.157 volts rms. If another 10 db attenuation is required, turn the range selector switch to the 10 MILLIVOLT position. The corresponding output voltage will be 0.05 volts rms.

Voltage gain for any range switch position up to 300 MILLIVOLTS is given by the relation:

$$\text{Voltage gain} = \frac{0.5 \text{ volts rms}}{\text{Full scale value of range setting}}$$

or: Voltage gain (db) = $20 \log \frac{0.5 \text{ volts rms}}{\text{Full scale value of range setting}}$

The amplifier consists of 3 common collector (emitter follower) stages and 6 common emitter stages. The common collector (emitter follower) stages will not reverse phase. The 6 common emitter stages will each provide a 180° phase shift which results in 6 x 180° or 3 x 360° phase shift; hence, input and output voltages are

in the same phase. Theoretically at mid frequencies there will be no phase shift due to reactive characteristics of the circuit and components, although such phase shift may be present at very high or very low frequencies. The exact amount of such phase shift cannot be guaranteed.

h. Battery Conservation

When the instrument is operated by the internal battery, it should be turned off when not in use to prolong battery life. Accuracy will not be affected by using the instrument immediately after turning it on as there is essentially no "warm-up" period required. If the instrument has not been used for extended periods (6 weeks or longer) a five minute stabilization period is recommended before use.

7. TEMPERATURE EFFECTS

As with most precision measuring equipment this instrument has certain temperature limitations. Accurate readings are obtained in normal temperatures. Avoid operation and storage in temperatures above 50°C (122°F). Storage in temperatures less than -40°C or -40°F should also be avoided. The following table will provide an idea of the accuracy of the instrument (except for the 300 volt range) as influenced by temperature.

TABLE II

Temperature	Full Scale Accuracy	Frequency
20°C to 30°C	±3%	20 cps to 300 kc
	±4%	300 kc to 1 mc
0°C to 20°C,	+3%, -4%	20 cps to 300 kc
30°C to 40°C	+4%, -5%	300 kc to 1 mc
-20°C to -0°C,	+4%, -5%	20 cps to 300 kc
40°C to 50°C	+5%, -6%	300 kc to 1 mc

8. APPLICATIONS

a. General

A complete understanding of instrument capabilities and effects on various circuits is necessary to obtain optimum accuracy in difficult measurements. This instrument measures average voltage levels of sinusoidal waveforms and the meter scale is calibrated in rms levels. The meter reading may be in error when the instrument is used to measure other than sinusoidal voltage waveforms. The instrument will accept voltage peaks up to twice the rms value of the input at full scale deflection without waveform clipping.

BEFD-4997-A
BEFD-4998-A

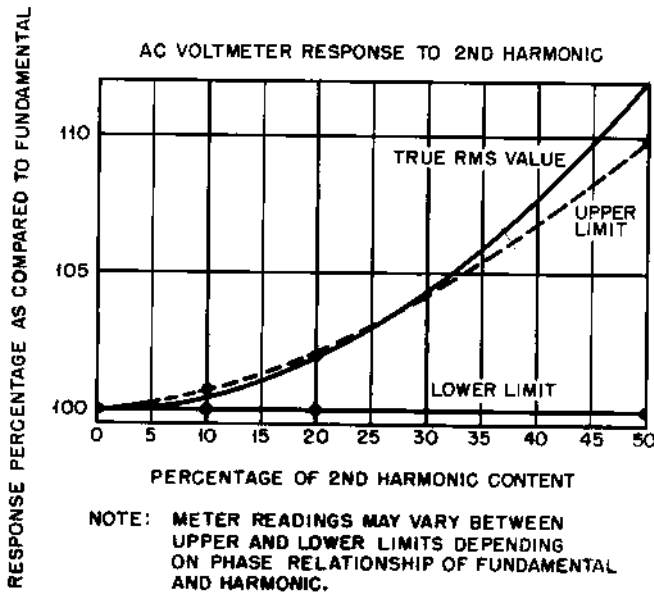

FIGURE 1.

The curves of figures 1 and 2 illustrate some of the effects of the harmonic content of non-sinusoidal waveforms on meter readings. It can be noted from these curves that the meter will always read lower than the true rms value when measuring waveforms having a second harmonic content. The meter may read higher or lower than the true rms value when measuring waveforms having a third harmonic content.

b. Voltmeter

A brief outline of typical applications for the a-c voltmeter is included to show the versatility of an instrument of this type. Unique uses for this instrument will be found as capabilities become more evident.

(1) Audio Frequency Measurements

Low level audio voltages generated in piezo-electric and magnetostrictive electromechanical devices (phonograph cartridges, tape recording and playback heads, and microphones) may be accurately measured on the lower ranges of the meter.

Voltage levels in audio and ultra-sonic amplifiers using either electron tubes or transistors may also be measured without disrupting the circuit under test.

Output voltages from power amplifiers, such as P. A. loudspeaker systems, may be measured across low impedance speakers and high impedance distribution lines without any loss of accuracy of the measuring instrument. However,

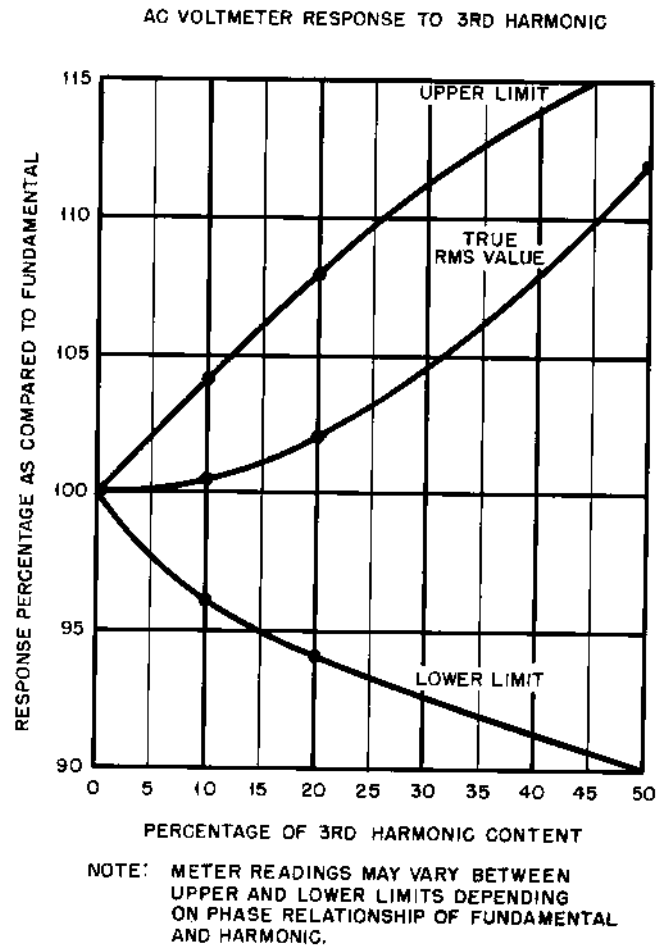

FIGURE 2.

do not exceed the maximum overload voltages as specified in the GUARANTEED PERFORMANCE SPECIFICATIONS chart included in this manual.

Hum levels of power supplies may also be measured. When d-c voltages in excess of the instrument rating (550 volts-sum of the a-c peak and d-c) are present, a 0.1 microfarad capacitor should be connected in series with the INPUT terminal and a 10 megohm resistor connected between the INPUT and GND terminals. Use a capacitor with a higher d-c voltage rating than that of the power supply being measured.

(2) Radio Frequency Measurements

The a-c voltmeter will accurately measure voltage levels in i-f and r-f amplifiers, mixers, detectors, oscillators and modulators using either electron tubes or transistors. Measurements at these higher frequencies should be performed using very short direct leads between the voltmeter and the circuit under test. This will avoid the capacitive shunting effects which are inherent in shielded cables and long test leads.

The input resistance and shunt capacity of the instrument must be considered when measuring voltages at radio frequencies. The loading effect is most predominant on high impedance tube circuits (especially on tuned circuits). The influence is considerably less on low impedance transistor circuits, where the shunt capacity of the instrument is normally a small part of the tuning circuit being measured.

With battery operation, the instruments are very useful as null indicators, since they are isolated from the a-c line.

NOTE

To completely isolate the S1053C Voltmeter from the a-c line and eliminate a-c pickup, remove the power cable plug from the rear of the unit.

WARNING

Place the voltmeter as far as possible from high power r-f transmitters to avoid possible r-f pick-up through the voltmeter aluminum housing.

The high sensitivity and low internal noise allows an accurate balance of the bridge circuit to be made. Due to the wide frequency response of the instrument, it is important that the oscillator supplying the bridge be completely free from harmonics.

c. Amplifier

Included in applications of the S1051C or S1053C equipment as an audio or radio frequency amplifiers are the following:

The instruments may be used as high gain pre-amplifiers for the amplification of low level audio voltages generated in piezo-electric and magnetostrictive electromechanical devices (phonograph cartridges, tape equipment heads, and microphones).

They may be used to amplify low signal level voltages generated by audio or r-f oscillators in order to drive frequency counters.

They may be used as isolation amplifiers with high input resistance and low impedance outputs. The input resistance is greater than 1 megohm in the MILLIVOLT position and greater than 10 megohms in the VOLTS position.

9. CALIBRATION AND MAINTENANCE

a. General

Accuracy of the S1051C and S1053C Transistorized AC Voltmeters can be maintained by periodic calibration of the instruments. Calibration should be accomplished only by qualified personnel having adequate test facilities. If desired, the Model S1051C or S1053C may be returned to the factory for calibration; refer to the Foreword for detailed information on shipment of the instruments.

The calibration procedure outlined herein may be used for recalibration of the instrument. However, if there have been any electrical component changes made such as replacement of diodes, transistors or range switch assembly, it is suggested that the instrument be returned to the factory for calibration.

Table III lists the test instruments required for calibration and maintenance of transistorized a-c voltmeters.

The voltmeter chassis may be removed from the case by loosening four screws at the back of the unit. In the a-c powered unit (Model S1053C), first unplug the power cord from the unit.

b. Calibration

(1) Noise Test

Cover the voltmeter input terminals with a shielded double banana plug across which is connected a 100K ohm resistor. Set the voltmeter range selector switch to 1 MILLIVOLT. The meter indication should be less than 0.1 on the top (0-1) meter scale.

(2) Needle Kick

(a) After the voltmeter has been "on" for at least two minutes, turn the range selector switch from the 1 VOLT position on to the 3 VOLT position. Note the needle kick. It should be less than 25% of full scale deflection.

(b) Return the range selector switch to the 1 VOLT position and note the needle kick. It should be less than 25% of full scale deflection.

TABLE III

Instrument Type	Minimum Required Specifications	Recommended Instrument
DC Multimeter	Sensitivity: 0.1 volt minimum for full scale deflection	Motorola DC Multimeter or equivalent
	Input Resistance: 11 megohms or higher	
	Accuracy: $\pm 3\%$ of full scale or better	
AC Voltmeter	Sensitivity: 1 millivolt minimum for full scale deflection	Motorola Transistorized AC Voltmeter
	Impedance: 1 megohm or higher	
	Accuracy: $\pm 3\%$ of full scale or better	
Voltmeter Calibrator	Accuracy: $\pm 0.25\%$ or better	Hewlett-Packard Model 738AR Voltmeter-Calibrator or equivalent
	Voltage Range: 1 mv, 3 mv, 10 mv; 100 volts, 300 volts, rms	
	Distortion: Less than 0.2%	
Test Oscillator	Output voltage: 1 mv, 3 mv, 10 mv; --- 3 volts; into 50 ohms	Hewlett-Packard Model 739AR Frequency Response Test Set or equivalent
	Frequency Range: 300 kc to 10 mc	
	Monitor Meter Accuracy: $\pm 0.5\%$ from 10 cps to 1 mc	
	Other Features: Provision for use with external oscillator	
General Purpose Oscillator (low output impedance):	Frequency Range: 5 cps to 600 kc	Hewlett-Packard Model 200SR Oscillator or equivalent
	Output: 3 volts min. into 50 ohms	
	Distortion: 0.5% max, below 500 kc	

(3) Input Resistance

(a) Connect the voltage calibrator to the input of the voltmeter.

(b) Set the voltage calibrator to 100 mv at 400 cps and adjust the calibrator gain control for a full scale reading on the voltmeter 100 MILLIVOLT range.

(c) Insert a parallel combination of a 1 megohm (film) resistor and a 30 uuf capacitor in series with the voltmeter input. The new voltmeter reading should be $1/2$ full scale or more for normal input resistance (1 megohm or greater).

(4) Linearity Test

(a) Turn the voltmeter OFF and place it upright on its feet. Set the meter indicator to zero with a screwdriver. Turn the voltmeter "on".

(b) Connect the voltage calibrator output to the voltmeter input terminals. Set the calibrator for 1 volt at 400 cps.

(c) Loosen the locknut on the GAIN control and adjust the control for full scale indication (1.0 volt) with the range selector switch in the 1 VOLT position. If this adjustment cannot be made, a malfunction exists in the voltmeter circuits. Do not continue with the test procedure until the trouble has been corrected. Refer to the Troubleshooting paragraph in this manual for instructions.

(d) Adjust the calibrator and check the voltmeter readings for inputs of 1.0 v, 0.8 v, 0.6 v, 0.4 v and 0.2 v.

(e) Place the voltmeter range selector switch in the 3 VOLT position. Adjust the calibrator and check the readings for inputs of 3.0 v, 2.5 v, 2.0 v, 1.0 v, and 0.5 v.

(5) 400 CPS Calibration

(a) Place the voltmeter in the normal position and reset the zero, if necessary, while the voltmeter is OFF.

(b) Place the range selector switch in the 1 MILLIVOLT position.

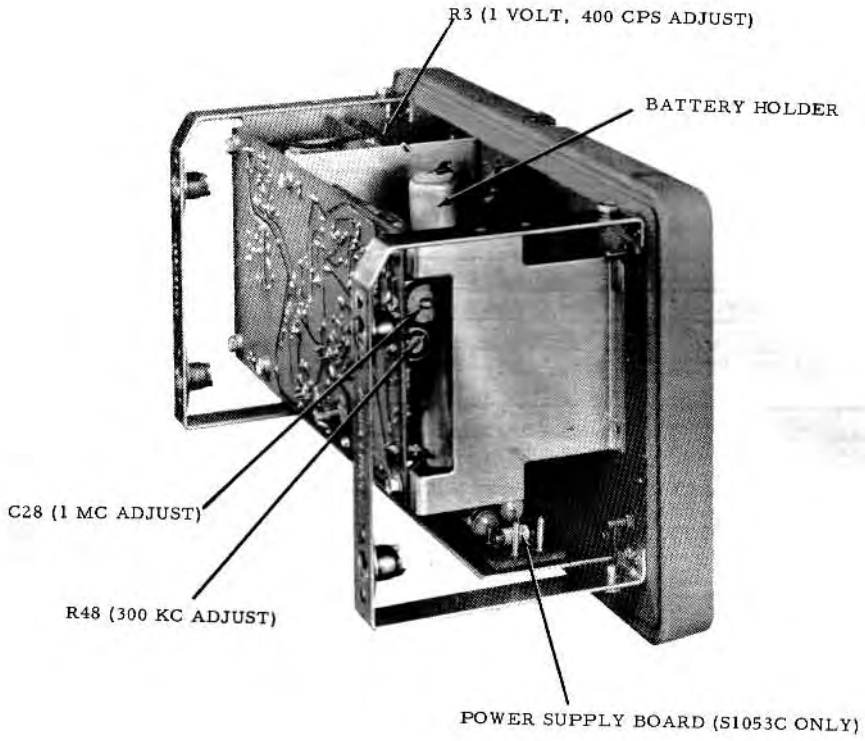

AEPD-9819-O(CE2286-X21)

Chassis Adjustments Detail

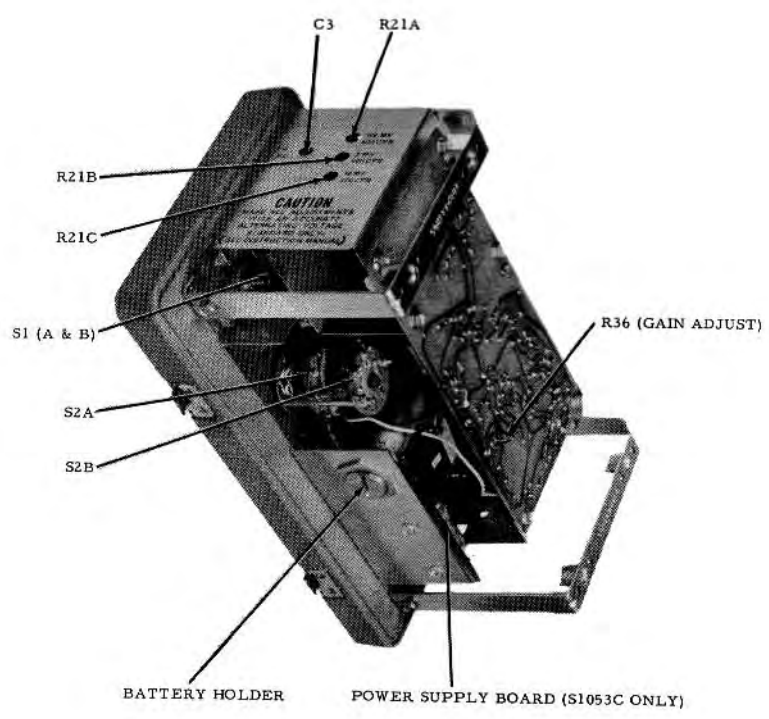

AEPD-9815-O(CE2286-W21)

Chassis Adjustments Detail

(c) Connect the voltage calibrator output to the voltmeter input with low-loss, shielded cable (RG-58/U, RG-59/U or equivalent) less than three feet in length.

(d) Set the calibrator output of 0.001 volt at 400 cps.

(e) Adjust the voltmeter GAIN control for a meter reading of 1.0 on the top scale.

(f) Secure the locknut on the GAIN control.

(g) Check the meter reading to be sure it still indicates 1.0 on the top scale. If not, loosen the locknut and repeat steps (d), (e) and (f).

NOTE

This is a basic adjustment upon which all others depend. It must be correct.

(h) Set the voltage calibrator and voltmeter range selector switch according to Table IV. Adjust the corresponding control for full-scale indication. These steps must be followed in order, namely, 100 mv first, then 10 mv, then 3 mv.

TABLE IV

Voltage Calibrator Setting	Voltmeter Range Position	Adjust for Full-Scale Indication
0.1 Volt 400 cps	100 MILLIVOLTS	100 MV Control (R21A)
0.01 Volt 400 cps	10 MILLIVOLTS	10 MV Control (R21C)
0.003 Volt 400 cps	3 MILLIVOLTS	3 MV Control (R21B)

(i) Repeat step (h) once or twice until no further adjustments are necessary.

(j) Turn the voltmeter range selector switch to 1 VOLT.

(k) Set the voltage calibrator to 1.0 volt.

(l) Adjust the 1 V, 400 cps control (R3) for full scale indication. This completes the 400 cps calibration.

(m) The accuracy of all other voltage ranges may be checked in a similar manner by using the voltage calibrator.

(n) Disconnect the voltage calibrator from the voltmeter.

(6) 1.0 MC Adjustment

(a) Set the controls on the frequency response generator (FRG) and the associated signal generator for an output of approximately 0.001 volt at 400 cps.

(b) Turn the voltmeter range selector to 1 MILLIVOLT.

(c) Connect the special output cable of the FRG to the voltmeter input terminals.

(d) Adjust the AMPLITUDE control of the signal generator until the voltmeter indicates 0.9 on the top scale.

(e) Use the FRG METER SET control to adjust the FRG meter indicator to one of the calibrating marks.

(f) Set the FRG to 1 mc (this will cause the FRG meter indicator to shift). Reset the meter indicator, with the amplitude control, to the same calibrating mark used in step (e).

(g) Turn the voltmeter H. F. TRIMMER (C28) for a meter indication of 0.9 on the top scale.

(h) Set the signal generator to 300 kc and adjust the signal generator AMPLITUDE control for the same calibrating mark used in step (e). Note the voltmeter reading.

(i) If the voltmeter reading of step (h) is higher than the reading taken at 1 mc (by more than 1/2 %), turn the trimmer potentiometer (R48) counterclockwise about 20°.

(j) Repeat steps (f) and (g).

(k) Repeat Step (h). If the voltmeter reading is still higher than the 1 mc reading (by more than 1/2%), repeat step (i) and then steps (f) and (g) until the 300 kc reading is within 1/2% of the 1 mc reading.

NOTE

If the voltmeter reading is low at 300 kc in step (i), turn the trimmer potentiometer clockwise, then proceed to steps (f), (g) (h), and (k).

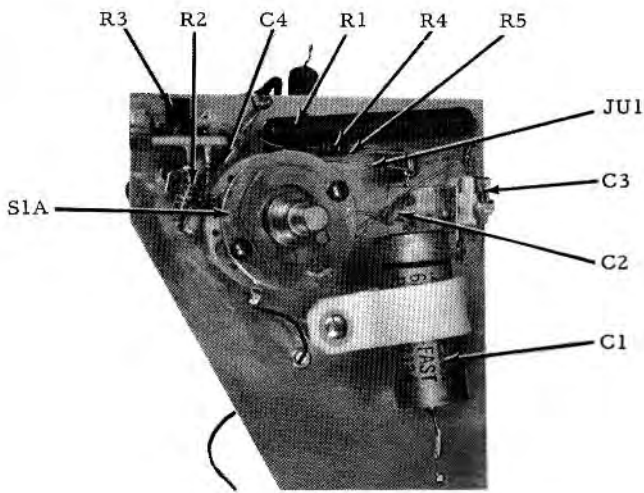

RANGE SWITCH ASSEMBLY
(FRONT)

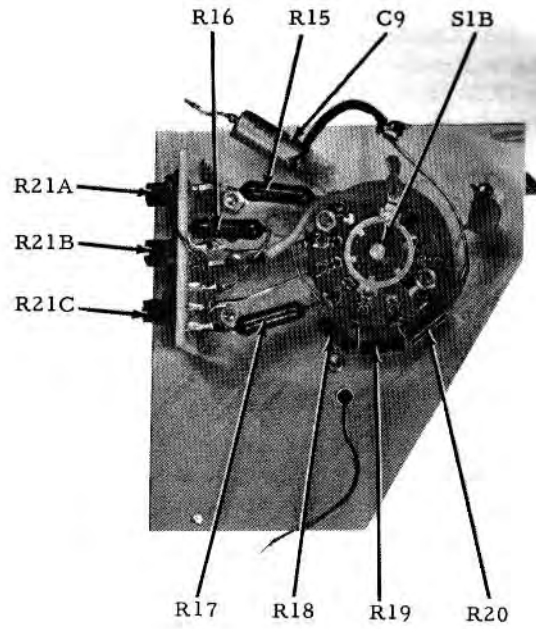

RANGE SWITCH ASSEMBLY
(REAR)

AEPD-9818-O(CE2286-Z21)
AEPD-9817-O(CE2286-A22)

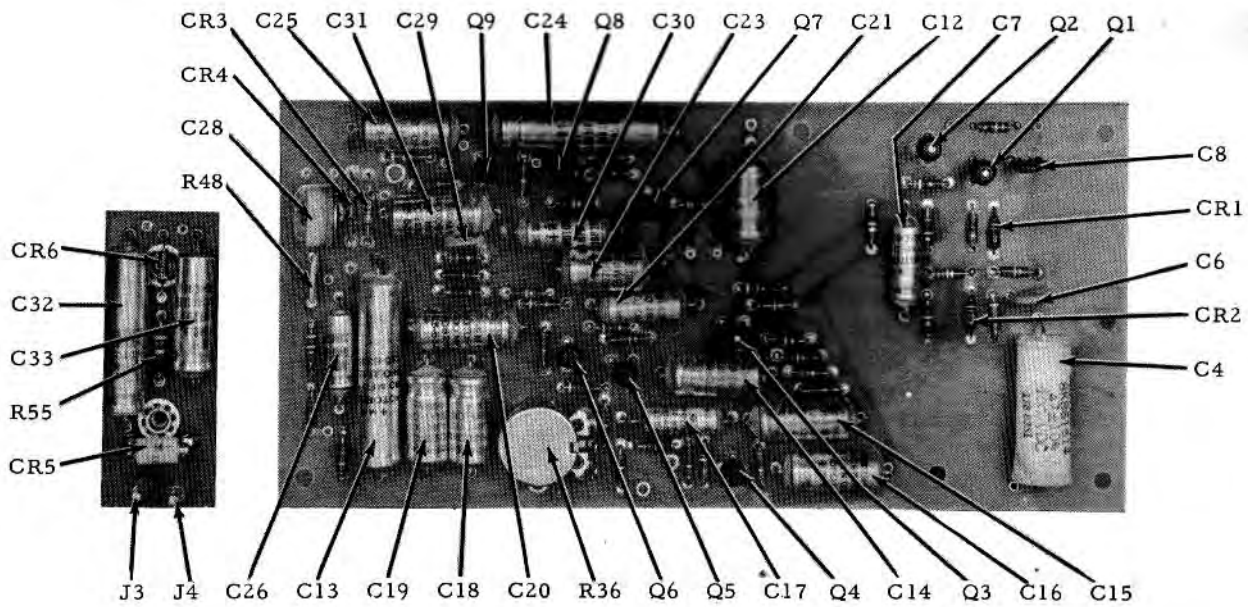

POWER
SUPPLY
BOARD

MAIN CIRCUIT BOARD

Component Location Details

AEPD-9816-O(CE2286-Y21)

(l) Turn the voltmeter range selector switch to 1.0 VOLT.

(m) Set the FRG for 1.0 volt at 400 cps. Adjust the AMPLITUDE control of the signal generator until the voltmeter indicator stands at 0.9 volt.

(n) Repeat steps (e) and (f).

(o) Turn the voltmeter 1 MC IV control (C3) for a meter indication of 0.9 on the top scale.

(p) Set the FRG for 400 cps and adjust the meter indicator, with the AMPLITUDE control, to the same calibrating mark used in step (e).

(q) Note the voltmeter indication. It should change less than 1/4% of the former 0.9 reading. If a greater change is noted, recalibrate according to steps 5(c), (j), (k) and (l) and steps 6(c) and (l) through (p).

c. Troubleshooting

Tables are provided to aid the serviceman in locating troubles quickly. TABLE V shows symptoms and possible causes. TABLES VI and VII give typical transistor (and power supply) a-c and d-c voltages. To check these voltages as well as resistor values, continuity, etc., refer to Component Location Detail on page 12.

NOTE

Resistance measurements should be made from the printed circuit rather than from component leads. This testing method reveals defects that may otherwise go unnoticed.

CAUTION

Measuring circuit and component resistances with ohmmeters using probe voltages greater than 200 millivolts can damage transistors and tantalum capacitors. Refer to the table of test equipment required (TABLE III) for recommended test instruments.

Should it become necessary to replace transistors or diodes, remember that they can be damaged by excessive heat. When replacing them, keep a pair of long nose pliers between the transistor (or diode) and the circuit board while soldering. The pliers will absorb enough heat to protect the transistor.

CAUTION

To avoid damage to batteries and transistors during repair and replacement of components, always turn the voltmeter OFF before removing batteries. No part is to be replaced while batteries are still in the voltmeter.

Replacement transistors must be ordered by Motorola part numbers only; this is necessary to maintain optimum performance. In emergencies, an N-P-N high frequency silicon (Star Planar) transistor can be substituted if available until the exact replacement part is obtained.

NOTE

If it becomes necessary to replace any electrical components such as transistors, diodes (except CR5 and CR6), the range switch assembly or components associated with the range switch, it is suggested that the instrument be returned to the factory for recalibration.

TABLE V

Symptoms	1st Possible Cause	2nd Possible Cause
Meter indication erratic (reading more than .1 mv) with input shielded and terminated in 100K ohms.	Q1, Q2 noisy	C9 leaky, Q3
Excessive needle kick when slowly changing from 1 to 3 volt range.	C9 leaky	C12 leaky
All ranges, 400 cps OK but 1 mc low.	C28, C6 open	
MV ranges: 400 cps OK; 1 mc OK; V ranges: 400 cps OK; 1 mc low.	C2, C3 open or misadjusted	
MV ranges: 400 cps OK; 1 mc OK; V ranges: 400 cps OK; 1 mc high.	C4 open	
MV ranges: 400 cps OK; 1 mc OK; V ranges: 400 cps & 1 mc low.	C7 open	R3 misadjusted
MV ranges: 400 cps OK; 1 mc OK; V ranges: 400 cps & 1 mc high.	R1, R2, R3	
Readings 50% low on VOLT ranges only.	C5 shorted	
Readings 10% low at 400 cps. Low input resistance.	C7	
Readings beyond full scale.	R35, R36	
Meter still shows a reading when meter is turned off (1 minute).	Static charge on meter face	Sticky meter or broken band
No meter reading.	C1 case shorted to ground	CR1, CR2, CR3, CR4
No reading on some ranges.	2nd attenuator resistors open	S1B
Intermittent B+ CHK. position reading.	Bad batt; leaky C23	R43, R49, R50 or R52
No amplifier output, but meter indicates amplifier input.	Q9	S2B (rear) or wiring
BATT. TEST reading beyond full scale.	Shorted C23	R43, R49, R50 or R52
No B+ OK reading when using a-c line.	CR5, CR6	T1 open; C32, C33 shorted
B+ CK. reading high (a-c operation only).	CR6 open	
Meter reads below zero and comes back to zero after a few seconds when power is turned off.	This is normal to charge on C23 and C30	
S1053C only: Needle kick or deflection when "LINE" side of the Function Switch is turned to B+ CHK., METER or OUTPUT position with the power cable unplugged from the a-c line.	This is normal due to charge left on the capacitors.	

TABLE VI
Typical DC Potentials*

Transistor	Emitter	Base	Collector
Q1	3.2	3.6	6.1
Q2	2.6	3.2	6.1
Q3	1.1	1.6	3.0
Q4	2.42	3.0	4.6
Q5	0.87	1.37	3.4
Q6	2.8	3.4	5.2
Q7	0.1	0.65	1.25
Q8	0.7	1.25	4.1
Q9	3.55	4.1	8.2

*Voltages taken with Motorola DC Multimeter (11 megohms input resistance) after the instrument being measured has been turned on, function selector switch set to OUTPUT position, and input terminals shorted.

TABLE VII

Typical AC Potentials (voltmeter turned on, function selector switch in output position, and range switch in 1 MILLIVOLT position)
Input = 1 MV at 400 CPS*

Transistor	Emitter	Base	Collector
Q1	0.97 mv	-	-
Q2	0.93 mv	-	-
Q3	-	0.93 mv	-
Q4	-	-	5.8 mv
Q5	-	5.8 mv	-
Q6	-	-	50 mv
Q7	-	50 mv	-
Q8	-	-	510 mv
Q9	500 mv	-	-

*Measurement made with Motorola Transistorized AC Voltmeter.

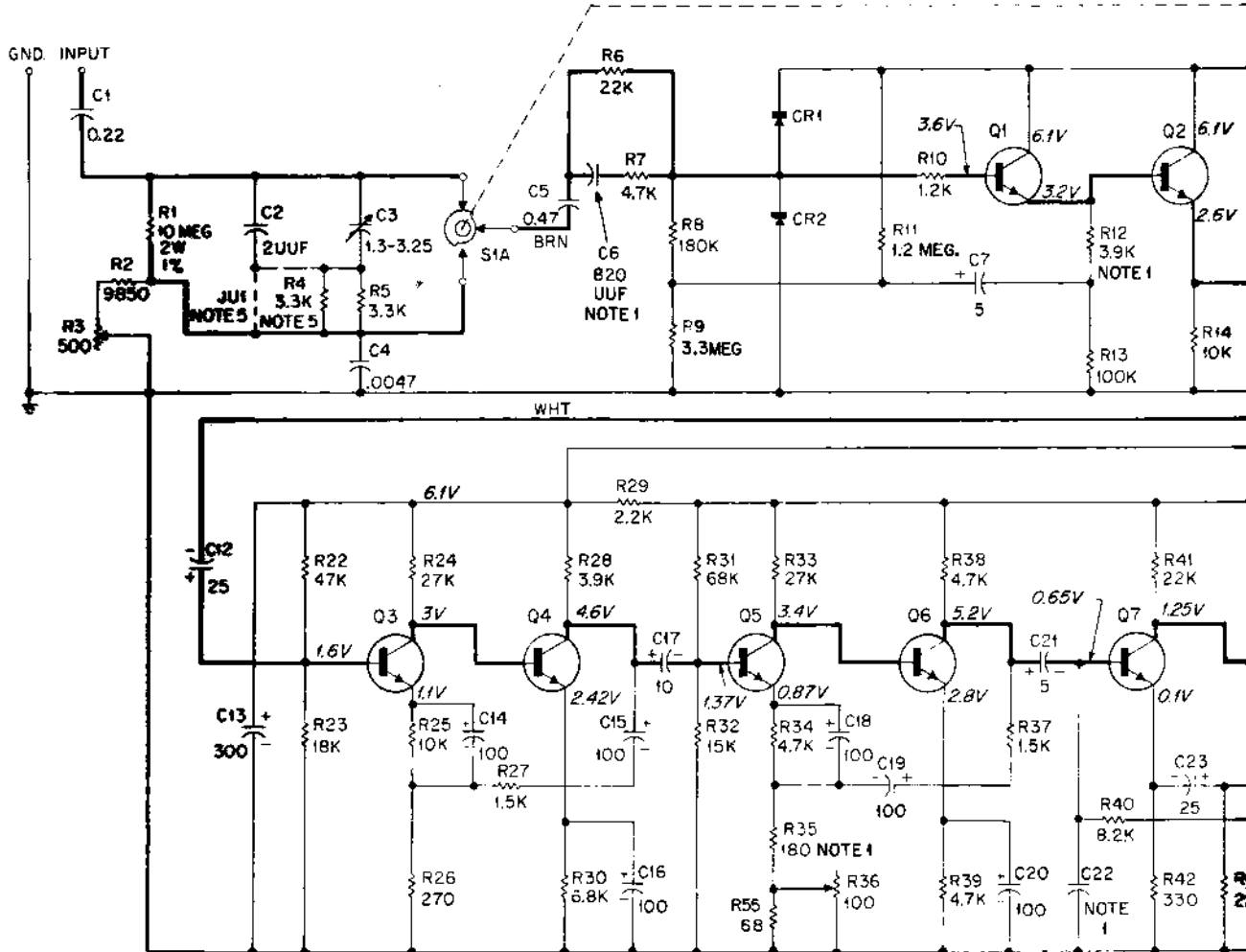

TRANSISTOR DETAIL (BOTTOM VIEW)

Q1 THROUGH Q9

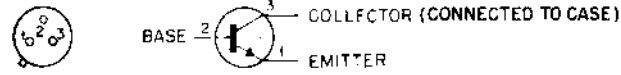

MODEL	SUFFIX	MODEL	SUFFIX
S1051C		SLN6013C	2
		SLN6099A	BAT

DIODE DETAIL

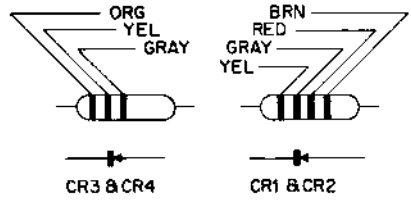

PART NAME MODEL S1051C BATTERY POWERED AC VOLT METER SCHEMATIC DIAGRAM

THIS DRAWING REQUIRES:
 NOTES. EPD-9656
 MODEL TABLE, EPD-9657

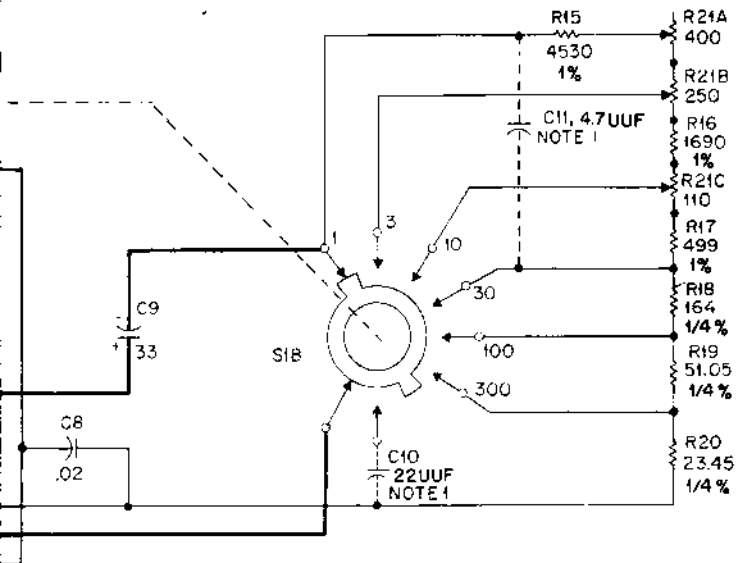

- NOTES:
1. COMPONENT VALUES SELECTED AT FACTORY (IF COMPONENT IS USED). VALUES, WHEN SHOWN, ARE TYPICAL.
 2. VOLTAGE READINGS ARE TYPICAL VALUES MEASURED WITH A MOTOROLA DC MULTIMETER (11 MEGOHM INPUT RESISTANCE) WITH RESPECT TO CHASSIS.
 3. RANGE SWITCH S1 SHOWN IN 1 MILLIVOLT POSITION (EXTREME COUNTERCLOCKWISE POSITION AS VIEWED FROM FRONT).
 4. UNLESS OTHERWISE STATED, RESISTANCE VALUES ARE IN OHMS ±5%, 1/4 WATT. K - 1000. CAPACITOR VALUES ARE IN MICROFARADS.
 5. CIRCUIT CONFIGURATION INVOLVING J11 AND R4 IS DETERMINED AT FACTORY.
 6. FUNCTION SELECTOR SWITCH S2 IS SHOWN IN OFF POSITION.

EPD-9656-0

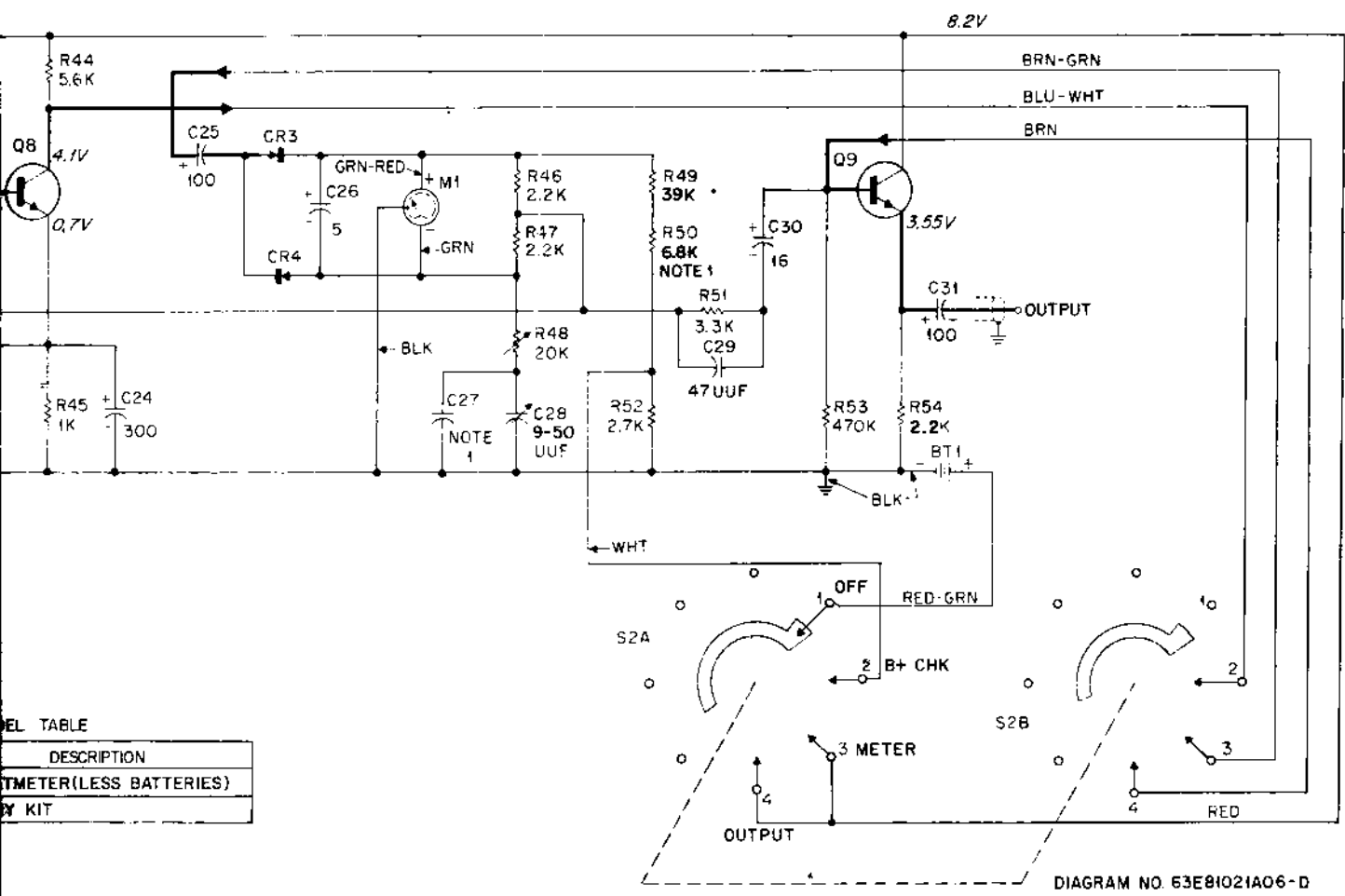

MODEL TABLE
DESCRIPTION
VOLTMETER (LESS BATTERIES)
BY KIT

DIAGRAM NO. 63E81021A06-D

FUNCTION SWITCH S2A (S2B) IS SHOWN IN EXTREME C.C.W. POSITION

PREVIOUS REVISIONS AND PARTS LIST SHOWN ON BACK OF THIS DIAGRAM

Model S1051C Transistorized AC Voltmeter
 And Amplifier Battery Powered
 Schematic Diagram
 Motorola No. 63E81021A06-D
 2/27/73-UP

REVISIONS

63F81021A06-D

CHASSIS AND SUFFIX NO.	REF. SYMBOL	CHANGE	LOCATION
SLN6013C	R9	WAS 6R131858, 270K	Q1 BASE CIRCUIT
	R11	WAS 6K128683, 150K	Q1 COLLECTOR
	R54	WAS 6K129707, 2.7K	Q2 EMITTER
S1051C	R54	ADDED	PARTS LIST
S1651C-1	R55	ADDED 47 OHMS	Q2 EMITTER
	R58	WAS 47 OHMS 6R131274	
SLN6013C-1	C11	WAS 21K852259, 3 UUF	51B-1
	R49	WAS 6R131527, 47K	52A-2
	R50	WAS 6S129829, 1.8K	
SLN6013C-2	R11	WAS 6K129239, 2.7 MEK	Q1 EMITTER
	CR3, 4	FROM 48B82691B01 TO 48C82139G01	PARTS LIST

PARTS LIST for Schematic Diagram 63D81021A06-D

SLN6013C AC Voltmeter

REFERENCE SYMBOL	MOTOROLA PART NO.	DESCRIPTION
C1	8C865794	CAPACITOR, fixed: uF; unl stated .22 ±20%; 600 v
C2	21K857336	2.0 uuf ±.25 uuf; 500 v; NPO
C3	19B82684B01	var.; 1.30-3.25 uuf; 850 v
C4	8C867238	.0047 ±10%; 400 v
C5	8K861614	.47 ±10%; 100 v
C6	21K837745	(factory selected) 820 uuf ±10%; 500 v
C7, 21, 26	23D82601A11	5 +33-10%; 25 v
C8	21K832502	.02 +60-40%; 250 v
C9	23B82783B07	33 ±20%; 25 v
C10	21R124554	(factory selected) 22 uuf ±5% NPO
C11	21R122942	4.7 uuf ±0.5 uuf; 500 v
C12, 23	23D82601A26	25-10 +150%; 20 v
C13	23C82077C07	300-10 +150%; 10 v
C14, 15, 16, 18, 19, 20, 25, 31	23C82601A12	100-10 +150%; 6 v
C17	23D82601A23	10-10 +150%; 20 v
C22		(factory selected)
C24	23D82601A18	300-10 +150%; 6 v
C27		(factory selected)
C28	20C8260E01	var.; 9-50 uuf; 350 v; N750
C29	21K859211	47 uuf ±5%; 300 v
C30	23D82601A10	16-10 +33%; 10 v
CR1, 2	48B864199	SEMICONDUCTOR DEVICE, diode: (SEE NOTE 1) silicon
CR3, 4	48C82139G01	germanium, coded ORG-YEL- GRAY (NOTE 2)
M1	72D82322G01	METER, multi-scale: 0-1 volt; 0-3 volts; -10 to +2 db
Q1, 2, 3	48K869159	TRANSISTOR: (SEE NOTE 1) N-P-N; coded WHT DOT
Q4, 5, 6, 7, 8, 9	48R869149	N-P-N; type M9149
R1	6D82673B04	RESISTOR, fixed: ±5%; 1/4 w; unl stated 10 meg ±1%; 2 w
R2	6D82672B05	9850 ±1%; 1/2 w
R3	18C82692B01	var.; 500 ±20%
R4, 5, 51	6K129231	3.3K
R6, 41, 43	6K128685	22K
R7, 34, 38, 39	6K129669	4.7K
R8	6S124B04	180K
R9	6K129011	3.3M ±10%
R10	6K129708	1.2K
R11	6S129864	1.3M ±10%
R12, 28	6K129819	3.9K
R13	6S124A97	100K
R14, 25	6K129668	10K
R15	6D82475B38	4530 ±1%; 1/2 w
R16	6D82475B39	1690 ±1%; 1/2 w
R17	6D82475B40	499 ±1%; 1/2 w
R18	6D82672B03	164 ±1/4%; 1/2 w
R19	6D82672B01	51.05 ±1/4%; 1/2 w
R20	6D82672B02	23.45 ±1/4%; 1/2 w
R21	18C82675B01	var; 3 sect.; c/o:
R21A		400 ±20%
R21B		250 ±20%
R21C		110 ±20%
R22, 49	6R131527	47K
R23	6K131526	18K
R24, 33	6K129886	27K
R26	6K131525	270
R27, 37	6K129681	1.5K
R29, 46, 47, 54	6K129804	2.2K
R30	6K129237	6.8K
R31	6K129299	68K
R32	6K129236	15K
R35	6K129431	180
R36	18C82676B01	var; 100 ±20%; 0.2 w
R40	6K129983	8.2K
R42	6K129806	330
R44	6K129982	5.6K
R45	6K129605	1K
R48	18K867137	var; 20K
R49	6R129777	39K
R50	6S128687	6.8K ±10%
R52	6K129707	2.7K
R53	6K129149	470K
R55	6S124A21	68

REFERENCE SYMBOL	MOTOROLA PART NO.	DESCRIPTION
11	40C82687B02	<u>SWITCH, rotary:</u> 2 sect.; 12 position; shorting type
12	40C82288H01	2 sect.; 4 position; non-shorting type
NON-REFERENCED ITEMS		
	1V80736A68	RANGE SWITCH ASSY; incl R1 thru R5, R15 thru R20, C1 thru C4 and C9 thru C11
	36C82289H02	KNOB, control
	36B82479B01	KNOB (range selector switch)
	42B82673B02	HOLDER, batt.: incl hdwe
	46B865778	POST, binding: black
	46K865779	POST, binding: red
	14K865780	INSULATOR, binding: 2 req'd
	26C82980B02	SHIELD, cover
	38A82978B02	PLUG, button
	1V80736A69	CIRCUIT BOARD ASSY: incl Q1 thru Q9, R6 thru R14, R21 thru R54, C5 thru C8 and C12 thru C31
	1V80714A75	HOUSING ASSY: incl 55A82436B01 HINGE, front cover 55A879706 CATCH, strike; 75A82566B01 BUMPER, rubber; and 55B82551B01 HANDLE
	1V80709A37	FRONT COVER ASSY: incl 75A82467B01 RUBBER MOLDING 32" length req'd
	42B82673B02	BATTERY HOLDER AND HARDWARE
LN6099A Battery Kit		
BT1	60B82292H01	<u>Battery, mercury:</u> 8.4 volt; 6 cell

NOTES:

1. Replacement transistors and diodes must be ordered by Motorola part number only for optimum performance.
2. CR3 and CR4 are a matched pair and must be replaced together.

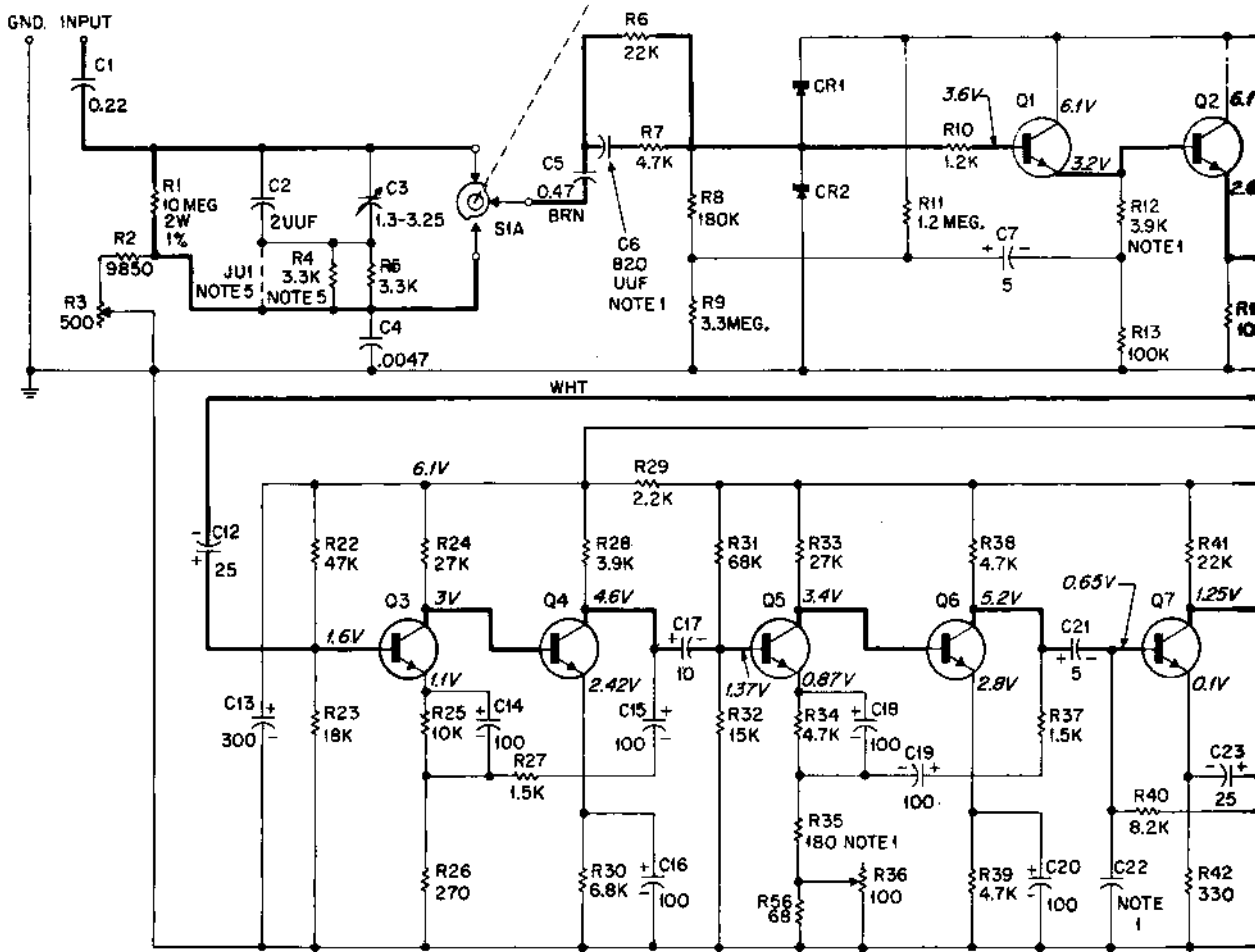

TRANSISTOR DETAIL (BOTTOM VIEW)

Q1 THROUGH Q9

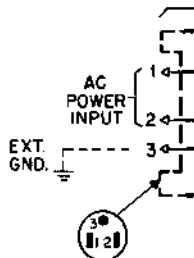
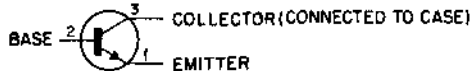

DIODE DETAIL

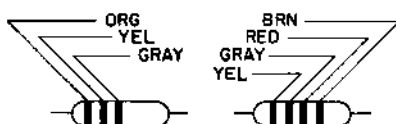

CR3 & CR4

CR1 & CR2

MODEL TABLE

MODEL	SUFFIX	MODEL	SUFFIX	DESCRIPTION
S1053C	1	SLN6045C	2	AC VOLTMETER (LESS POWER SOURCE)
		SLN6008A		POWER CABLE KIT
		SLN6099A		BATTERY KIT

REVISIONS

68E81021A64-D

CHASSIS AND SUFFIX NO.	REF. SYMBOL	CHANGE	LOCATION
SLN6045C	R9	WAS 6R131858, 270K	Q1 BASE CIRCUIT
	R11	WAS 6K128683, 150K	Q1 COLLECTOR
	R54	WAS 6K129707, 2.7K	Q9 EMITTER
SL053C	R56	ADDED: 47	Q5 EMITTER
SL053C-1	R56	WAS: 47, 6R131274	
SLN6045C-1	C14	WAS 21K852259, 3 UUF	S1B-1
	R49	WAS 6R131527, 47K	S2A-2
	R50	WAS 6S129820, 1.8K	
SLN6045C-1	R11	WAS 6K129239, 2.7 MEG	Q1 EMITTER
	CR3, 4	FROM 48B82691B01 TO 48C82139G01	PARTS LIST

PARTS LIST for Schematic Diagram 63E81021A64-D

SLN6045C AC Voltmeter

REFERENCE SYMBOL	MOTOROLA PART NO.	DESCRIPTION
C1	8C865794	CAPACITOR, fixed: uf; unl stated 0.22 ±20%; 600 v 2.0 uf ±.25 uf; 500 v; NPO var.; 1.30-3.25 uf; 850 v .0047 ±10%; 400 v .47 ±10%; 100 v (factory selected) 820 uf ±10%; 500 v 5 +33-10%; 25 v .02 ±60-40%; 250 v 33 ±20%; 25 v (factory selected) 22 uf ±10% NPO 4.7 uf ±0.5 uf; 500 v 25 +150-10%; 20 v 300 +150-10%; 10 v 100 +150-10%; 6 v 10 +150-10%; 20 v (factory selected) 300 +150-10%; 6 v (factory selected) var.; 9-50 uf; 350 v; N750 47 uf ±5%; 300 v 16 +33-10%; 10 v 100 +150-10%; 25 v 100 +150-10%; 20 v
C2	21K857336	
C3	19B82684B01	
C4	8C867238	
C5	8KB61614	
C6	21K837745	
C7, 21, 26	23D82601A11	SEMICONDUCTOR DEVICE, diode: (SEE NOTE 1) silicon germanium, coded ORG-YEL-GRAY (NOTE 2) germanium silicon: 8.2 v zener diode CONNECTOR, receptacle: female; 3 contact male; 1 contact METER multi-scale: 0-1 volts; 0-3 volts; -10 to +2 db CONNECTOR, plug: female; 2 contact TRANSISTOR: (SEE NOTE 1) N-P-N; coded WHT DOT N-P-N; type M9149 RESISTOR, fixed: ±5%; 1/4 w; unl stated 10 meg ±1%; 2 w 9850 ±10%; 1/2 w var.; 500 ±20% 3.3K 22K 4.7K 180K 3.3M ±10% 1.2K 1.2 meg ±10% 10K 4530 ±1%; 1/2 w 1690 ±1%; 1/2 w 499 ±1%; 1/2 w 164 ±1/4%; 1/2 w 51.05 ±1/4%; 1/2 w 23.45 ±1/4%; 1/2 w var.; 3 section; c/o: 400 ±20% 250 ±20% 110 ±20% 47K 18K 27K 270 1.5K 2.2K 6.8K 68K 15K 180 var.; 100 ±20%; 0.2 w 8.2K 330
C8	21K832502	
C9	23B82783B07	
C10	21R124554	
C11	21R122942	
C12, 23	23D82601A26	
C13	23C82077C07	
C14, 15, 16, 18, 19, 20, 25, 31	23C82601A12	
C17	23D82601A23	
C22	23D82601A18	
C24	23D82601A18	
C27	20C82860B01	
C28	21K859211	
C29	23D82601A10	
C30	23D82601A09	
C32	23D82601A25	
C33	23D82601A25	
CR1, 2	48B864199	
CR3, 4	48C82139G01	
CR5	48B822526	
CR6	48D82256C16	
J1	9B82137E01	
J3, 4	29A852137	
M1	72D82322G01	
P3	9B82381H01	
Q1, 2, 3	48K869159	
Q4, 5, 6, 7, 8, 9	48R869149	
R1	6D82672B04	
R2	6D82672B05	
R3	18C82692B01	
R4, 5, 51	6K129231	
R6, 41, 43	6K128685	
R7, 34, 38, 39	6K129669	
R8	6S124E04	
R9	6K129011	
R10	6K129708	
R11	6S129864	
R14, 25	6K129668	
R15	6D82475B38	
R16	6D82475B39	
R17	6D82475B40	
R18	6D82672B03	
R19	6D82672B01	
R20	6D82672B02	
R21	18C82675B01	
R21A		
R21B		
R21C		
R22	6R131527	
R23	6K131526	
R24, 33	6K129886	
R26	6K131525	
R27, 37	6K129681	
R29, 46, 47, 54	6K129804	
R30	6K129237	
R31	6K129299	
R32	6K129236	
R35	6K129431	
R36	18C82676B01	
R40	6K129983	
R42	6K129806	

REF. SY.
R44
R45
R48
R49
R50
R52
R53
R55
R56
S1
S2
SLN6
BT1
SKN6
P1
P2
T1
W1
NOT
1.
2.

REFERENCE SYMBOL	MOTOROLA PART NO.	DESCRIPTION
R44	6K129982	5.6K
R45	6K129805	1K
R48	18K867137	var.; 20K
R49	6S129777	39K
R50	6S128687	6.8K ±10%
R52	6K129707	2.7K
R53	6K129149	470K
R55	6R400057	270; 1/2 w
R56	6S124A21	68
S1	40C82687B02	<u>SWITCH, rotary:</u> 2 sect.; 12 position; shorting type
S2	40C82288H02	2 sect.; 8 position; non-shorting type

NON-REFERENCED ITEMS

1V80736A68	RANGE SWITCH ASSY: incl R1 thru R5, R15 thru R20, C1 thru C4 and C9 thru C11
36C83712D01	KNOB, control
36C82634H04	KNOB (range selector switch)
42B82673B02	HOLDER, batt.; incl hdwe
46B865778	POST binding; black
46K865779	POST binding; red
14K865780	INSULATOR, binding; 2 req'd
26C82980B02	SHIELD, cover
38A82978B02	PLUG, button
1V80736A69	CIRCUIT BOARD ASSY: incl Q1 thru Q9, R6 thru R14, R21 thru R55, C5 thru C8 and C12 thru C33
1V80736A71	POWER SUPPLY BOARD ASSY incl C32, C33, CR5, CR6, P4, P5, and R55
1V80736A73	HOUSING ASSY: incl J1, P3, 55A82436B01 FRONT HINGE COVER, 55A879706 STRIKE CATCH
42B82673B02	BATTERY HOLDER AND HDWE

SLN6099A Battery Kit

BT1	60B82292H01	<u>BATTERY, mercury:</u> 8.4 volt; 6 cell
-----	-------------	--

SKN6008A Cable, Power

P1	28C82138E01	<u>CONNECTOR, plug:</u> male; 3 contact; incl T1; p/o W1
P2		male; 3 contact
T1		<u>TRANSFORMER, power:</u> p/o P1; pri: 117 volt; sec: 9 v
W1		<u>CABLE, power:</u> incl P1, T1 and 30C82238E01 CABLE, power; 2 cond.; shielded; 6' length

NOTES:

1. Replacement transistors and diodes must be ordered by Motorola part number only for optimum performance.
2. CR3 and CR4 are a matched pair and must be replaced together.

K4XL's **BAMA**

This manual is provided **FREE OF CHARGE** from the "BoatAnchor Manual Archive" as a service to the Boatanchor community.

It was uploaded by someone who wanted to help you repair and maintain your equipment.

If you paid anyone other than BAMA for this manual, you paid someone who is making a profit from the free labor of others without asking their permission.

You may pass on copies of this manual to anyone who needs it. But do it without charge.

Thousands of files are available without charge from BAMA. Visit us at <http://bama.sbc.edu>